

DESIGN NOTES:

- IT IS THE RESPONSIBILITY OF THE DESIGN ENGINEER TO SIZE, DESIGN AND DETAIL ALL BIORETENTION STRUCTURES.
- PERIMETER WALL SHALL BE CAST-IN-PLACE REINFORCED CONCRETE. PROFESSIONAL ENGINEER IS RESPONSIBLE FOR STRUCTURAL DESIGN OF ALL WALLS, OUTLET STRUCTURES AND OTHER CONCRETE ELEMENTS (INCLUDING REBAR AND RAILINGS). IN ADDITION, ENGINEER MUST DETAIL CONCRETE PHASING AND CONNECTION OF STRUCTURES VIA DOWELING THROUGHOUT PHASED CONCRETE POURS.
- FOR NO INFILTRATION SECTION, SPRAY ON WATERPROOF LINING SHALL BE APPLIED TO ALL INTERNAL CONCRETE SURFACES. SPRAY ON WATERPROOF LINING SHALL BE RAVEN INDUSTRIES ECODUR SPRAY LINER SYSTEM OR APPROVED EQUAL.
- AS AN ALTERNATE TO SPRAY ON WATER PROOFING, AN IMPERMEABLE GEOMEMBRANE LINER MAY BE USED. IF IMPERMEABLE GEOMEMBRANE LINER IS INSTALLED BELOW DRAINAGE MEDIA, A LAYER OF NONWOVEN GEOTEXTILE SHALL BE PLACED BETWEEN THE LINER AND THE DRAINAGE MEDIA. IF SUBGRADE CONTAINS ANGULAR ROCKS OR OTHER MATERIAL THAT COULD PUNCTURE THE LINER, A LAYER OF NONWOVEN GEOTEXTILE SHALL ALSO BE PLACED BETWEEN THE LINER AND THE SUBGRADE (SEE CONSTRUCTION DRAWINGS FOR LINER REQUIREMENTS). LINER SHALL BE ATTACHED TO PERIMETER WALL (ALONG WITH GEOTEXTILE) USING FABRIC ATTACHMENT DETAIL. ALL LINER SEAMS SHALL BE WELDED. PVC BOOT SHALL BE USED FOR ALL UNDERDRAIN PENETRATIONS THROUGH LINER. WATER TIGHTNESS OF LINER SHALL NOT BE COMPROMISED DURING CONSTRUCTION OR LANDSCAPING OPERATION.
- UNDERDRAIN CLEANOUTS SHALL BE PROVIDED AT THE UPSTREAM END, UPSTREAM OF ANY BENDS 22 1/2 DEGREES OR GREATER AND AT A MAXIMUM SPACING OF 150 FEET. SEE GENERAL DETAILS SHEET FOR UNDERDRAIN DETAILS. ALL UNDERDRAIN BENDS SHALL BE 45 DEGREES OR LESS.
- BIORETENTION SURFACE SHALL BE SEEDED WITH NATIVE TURF GRASS (PER TABLE B-3, USDCM VOLUME 3, FACT SHEET T-3) OR SAND GROWN SOD. SEEDED AREAS SHALL BE PROTECTED WITH BIODEGRADABLE DOUBLE-NET 100% COCONUT FIBER EROSION CONTROL BLANKET UNTIL GRASS COVER IS ESTABLISHED. SHRUBS ARE NOT PERMITTED UNLESS ROCKS ARE PLACES AROUND THE BASE OF THE SHRUB, WITH THE ROCK COVERING NO MORE THAN 15% OF THE SURFACE AREA (SEE NOTE 7).
- TWO-INCH DIAMETER AND LARGER ROCK MAY BE USED AS AN ACCENT OR BARRIER BUT MAY NOT COVER MORE THAN 15% OF THE SURFACE AREA. WOOD MULCH IS NOT PERMITTED.
- AN IRRIGATION SYSTEM SHALL BE PROVIDED. IRRIGATION SHOULD BE PLACED OUTSIDE OF PERIMETER WALLS WHENEVER POSSIBLE. IF THE IRRIGATION SYSTEM WILL NOT PROVIDE ADEQUATE COVERAGE FROM OUTSIDE THE PERIMETER WALLS, IRRIGATION HEADS AND LATERALS SHALL BE LOCATED IN THE OUTSIDE 6-INCHES OF THE BIORETENTION MEDIA SURFACE.
- FINISHED GRADE SURROUNDING PERIMETER WALLS SHALL HAVE A MAXIMUM SLOPE OF 3:1. SLOPES STEEPER THAN 4:1 MUST BE BLANKETED, SODDED OR OTHERWISE STABILIZED.
- RUNOFF SHALL BE ROUTED INTO THE BIORETENTION FACILITY VIA PIPE, CONCRETE RUNDOWN, VOID-FILLED RIPRAP RUNDOWN OR VEGETATED SOIL RIPRAP. IF TRIBUTARY AREA IS GREATER THAN 4 ACRES TO AN INFLOW POINT, A FOREBAY IS REQUIRED.
- A HARD SURFACE MAINTENANCE ACCESS IS REQUIRED TO THE OUTLET STRUCTURE VIA SIDEWALK, PARKING LOT OR OTHER FORMALIZED PATH.
- UNDERDRAIN MUST HAVE MINIMUM SLOPE IDENTIFIED ON DETAIL. FOR NO INFILTRATION FACILITY, CONCRETE FLOOR CAN BE SLOPED AND/OR AASHTO #8 AGGREGATE THICKNESS INCREASED TO ACHIEVE 2" OF CLASS A ABOVE AND BELOW 4" UNDERDRAIN. FOR PARTIAL INFILTRATION FACILITY, SUBGRADE SHALL BE SLOPED PARALLEL TO UNDERDRAIN TO ACHIEVE MINIMUM SLOPE.
- STEPS SHALL BE PROVIDED IN THE OUTLET STRUCTURE WHEN THE DISTANCE FROM THE TOP OF GRATE TO THE INLET FLOOR IS GREATER THAN OR EQUAL TO 3.5 FEET. STEPS SHALL CONFORM TO AASHTO M199.
- ENERGY DISSIPATION RIPRAP PAD FINISHED GRADE ELEVATION MUST BE A MINIMUM OF 6" LOWER THAN PAVEMENT AT INFLOW POINT.

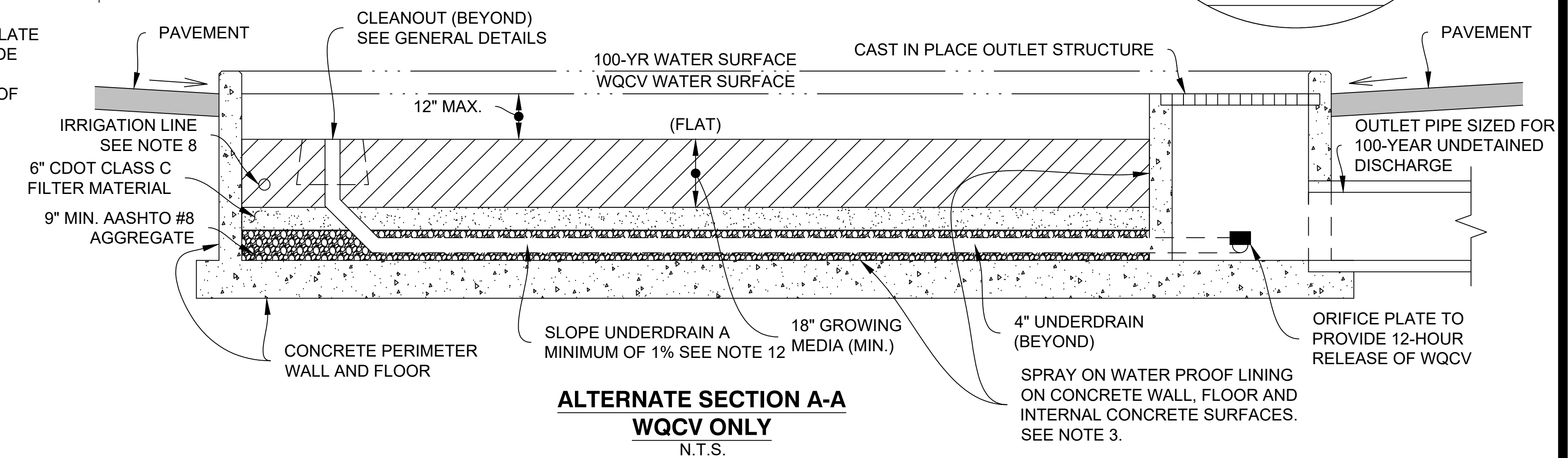
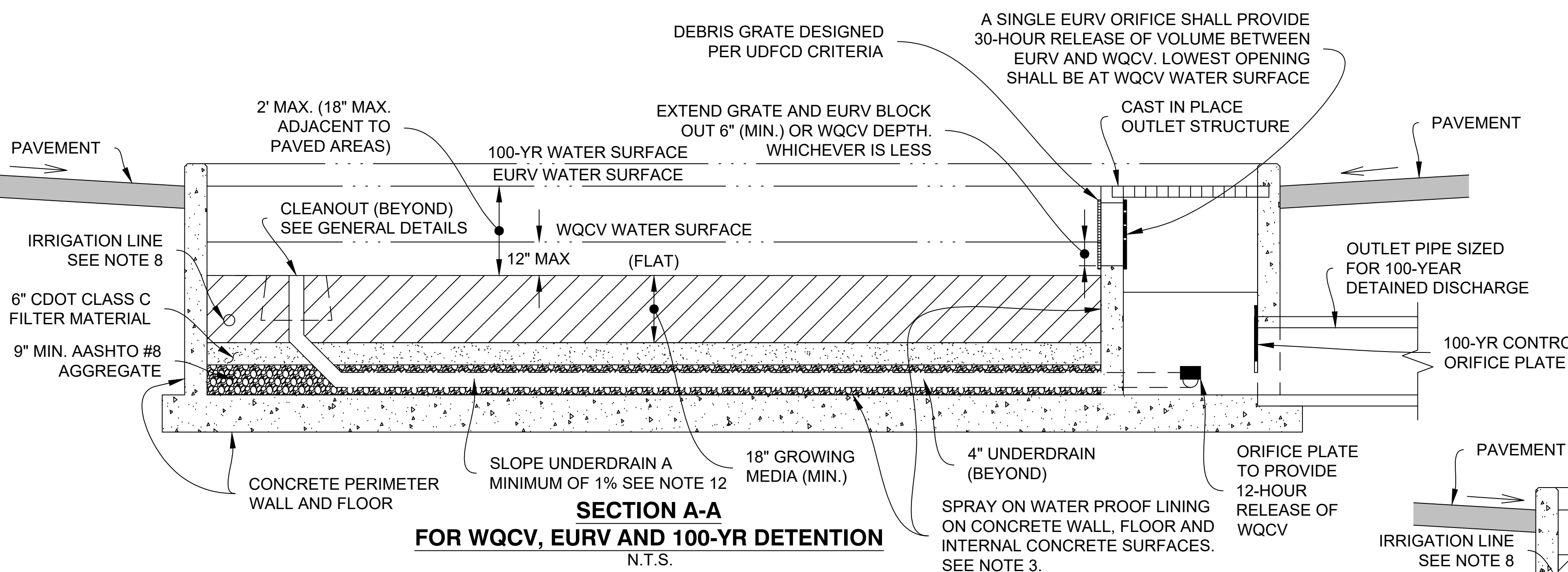
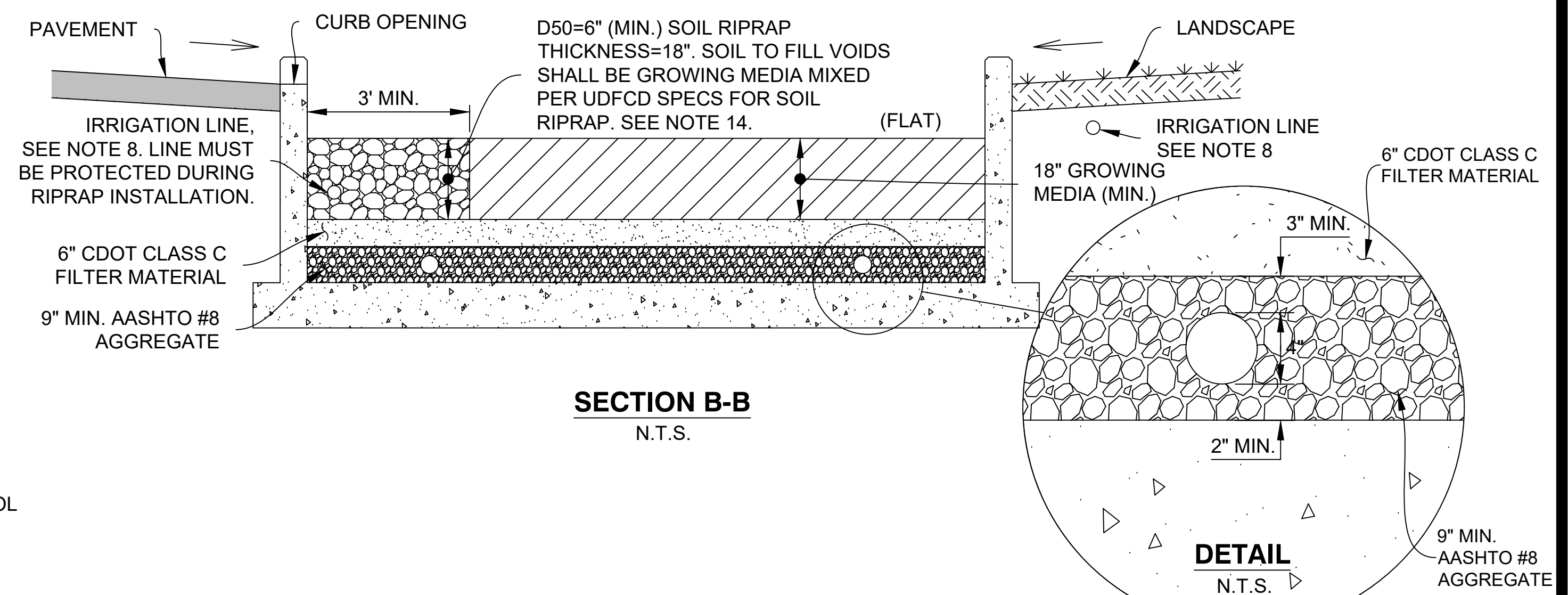

PLOTTED: 8/10/2020 5:09:46 PM

REFERENCE:	SCALE:	Standard Plan Revision		
		No.	Date	Description



6924 S. LIMA ST.
CENTENNIAL, CO 80112
PHONE (720) 874-6500
www.arapahoegov.com

**BIORETENTION (RAIN GARDEN)
CONSTRAINED (WITH WALLS)
NO INFILTRATION**

SHEET
1 OF 2

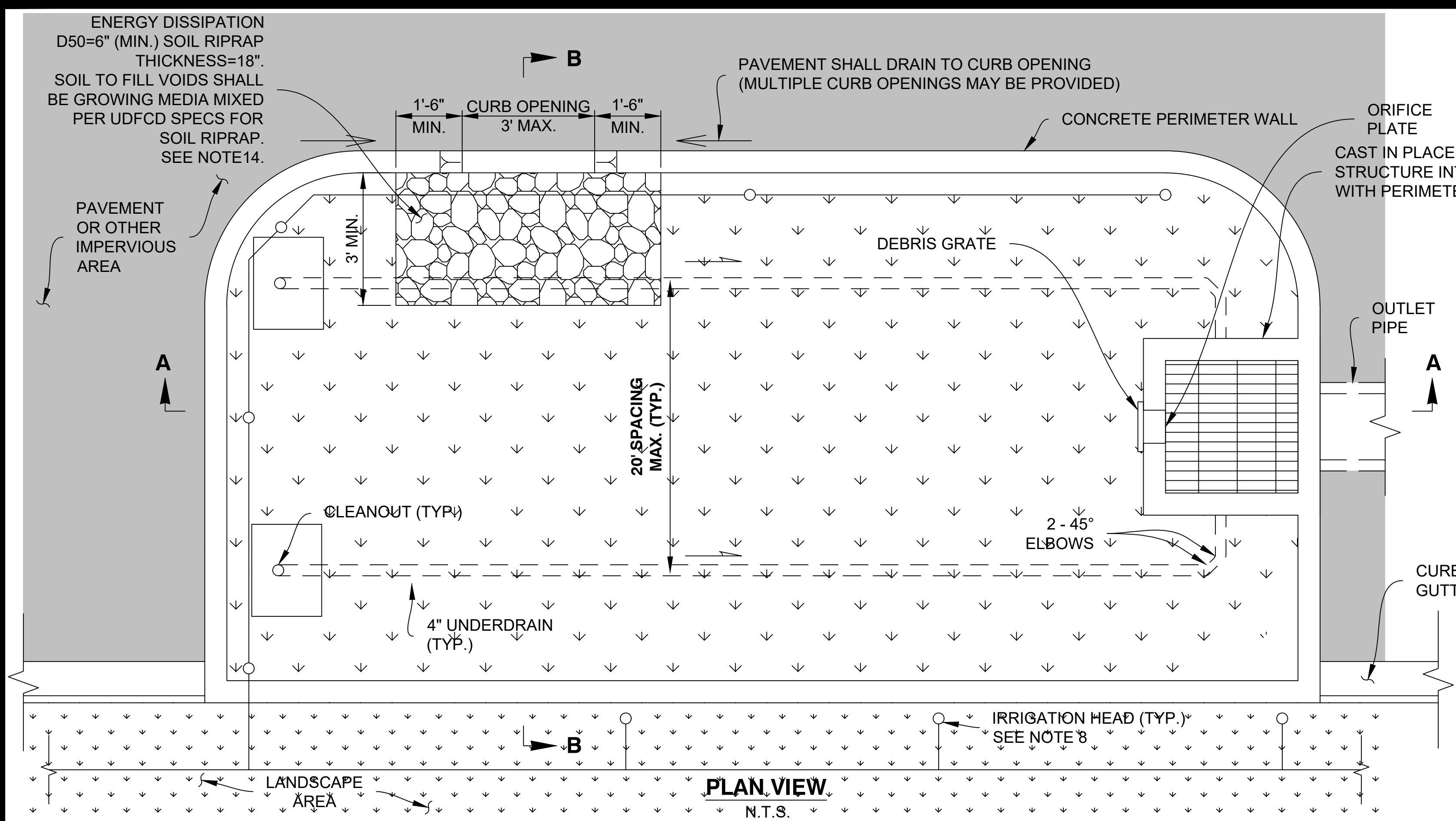

DESIGN NOTES:

1. IT IS THE RESPONSIBILITY OF THE DESIGN ENGINEER TO SIZE, DESIGN AND DETAIL ALL BIORETENTION STRUCTURES.
2. PERIMETER WALL SHALL BE CAST-IN-PLACE REINFORCED CONCRETE. PROFESSIONAL ENGINEER IS RESPONSIBLE FOR STRUCTURAL DESIGN OF ALL WALLS, OUTLET STRUCTURES AND OTHER CONCRETE ELEMENTS (INCLUDING REBAR AND RAILINGS). IN ADDITION, ENGINEER MUST DETAIL CONCRETE PHASING AND CONNECTION OF STRUCTURES VIA DOWELING THROUGHOUT PHASED CONCRETE POURS.
3. FOR NO INFILTRATION SECTION, SPRAY ON WATERPROOF LINING SHALL BE APPLIED TO ALL INTERNAL CONCRETE SURFACES. SPRAY ON WATERPROOF LINING SHALL BE RAVEN INDUSTRIES ECODUR SPRAY LINER SYSTEM OR APPROVED EQUAL.
4. AS AN ALTERNATE TO SPRAY ON WATER PROOFING, AN IMPERMEABLE GEOMEMBRANE LINER MAY BE USED. IF IMPERMEABLE GEOMEMBRANE LINER IS INSTALLED BELOW DRAINAGE MEDIA, A LAYER OF NONWOVEN GEOTEXTILE SHALL BE PLACED BETWEEN THE LINER AND THE DRAINAGE MEDIA. IF SUBGRADE CONTAINS ANGULAR ROCKS OR OTHER MATERIAL THAT COULD PUNCTURE THE LINER, A LAYER OF NONWOVEN GEOTEXTILE SHALL ALSO BE PLACED BETWEEN THE LINER AND THE SUBGRADE (SEE CONSTRUCTION DRAWINGS FOR LINER REQUIREMENTS). LINER SHALL BE ATTACHED TO PERIMETER WALL (ALONG WITH GEOTEXTILE) USING FABRIC ATTACHMENT DETAIL. ALL LINER SEAMS SHALL BE WELDED. PVC BOOT SHALL BE USED FOR ALL UNDERDRAIN PENETRATIONS THROUGH LINER. WATER TIGHTNESS OF LINER SHALL NOT BE COMPROMISED DURING CONSTRUCTION OR LANDSCAPING OPERATION.
5. UNDERDRAIN CLEANOUTS SHALL BE PROVIDED AT THE UPSTREAM END, UPSTREAM OF ANY BENDS 22 1/2 DEGREES OR GREATER AND AT A MAXIMUM SPACING OF 150 FEET. SEE GENERAL DETAILS SHEET FOR UNDERDRAIN DETAILS. ALL UNDERDRAIN BENDS SHALL BE 45 DEGREES OR LESS.
6. BIORETENTION SURFACE SHALL BE SEEDED WITH NATIVE TURF GRASS (PER TABLE B-3, USDCM VOLUME 3, FACT SHEET T-3) OR SAND GROWN SOD. SEEDED AREAS SHALL BE PROTECTED WITH BIODEGRADABLE DOUBLE-NET 100% COCONUT FIBER EROSION CONTROL BLANKET UNTIL GRASS COVER IS ESTABLISHED. SHRUBS ARE NOT PERMITTED UNLESS ROCKS ARE PLACES AROUND THE BASE OF THE SHRUB, WITH THE ROCK COVERING NO MORE THAN 15% OF THE SURFACE AREA (SEE NOTE 6).
7. TWO-INCH DIAMETER AND LARGER ROCK MAY BE USED AS AN ACCENT OR BARRIER BUT MAY NOT COVER MORE THAN 15% OF THE SURFACE AREA. WOOD MULCH IS NOT PERMITTED.
8. AN IRRIGATION SYSTEM SHALL BE PROVIDED. IRRIGATION SHOULD BE PLACED OUTSIDE OF PERIMETER WALLS WHENEVER POSSIBLE. IF THE IRRIGATION SYSTEM WILL NOT PROVIDE ADEQUATE COVERAGE FROM OUTSIDE THE PERIMETER WALLS, IRRIGATION HEADS AND LATERALS SHALL BE LOCATED IN THE OUTSIDE 6-INCHES OF THE BIORETENTION MEDIA SURFACE.
9. FINISHED GRADE SURROUNDING PERIMETER WALLS SHALL HAVE A MAXIMUM SLOPE OF 3:1. SLOPES STEEPER THAN 4:1 MUST BE BLANKETED, SODDED OR OTHERWISE STABILIZED.
10. RUNOFF SHALL BE ROUTED INTO THE BIORETENTION FACILITY VIA PIPE, CONCRETE RUNDOWN, VOID-FILLED RIPRAP RUNDOWN OR VEGETATED SOIL RIPRAP. IF TRIBUTARY AREA IS GREATER THAN 4 ACRES TO AN INFLOW POINT, A FOREBAY IS REQUIRED.
11. A HARD SURFACE MAINTENANCE ACCESS IS REQUIRED TO THE OUTLET STRUCTURE VIA SIDEWALK, PARKING LOT OR OTHER FORMALIZED PATH.
12. UNDERDRAIN MUST HAVE MINIMUM SLOPE IDENTIFIED ON DETAIL. FOR NO INFILTRATION FACILITY, CONCRETE FLOOR CAN BE SLOPED AND/OR AASHTO #8 AGGREGATE THICKNESS INCREASED TO ACHIEVE 2\"/>

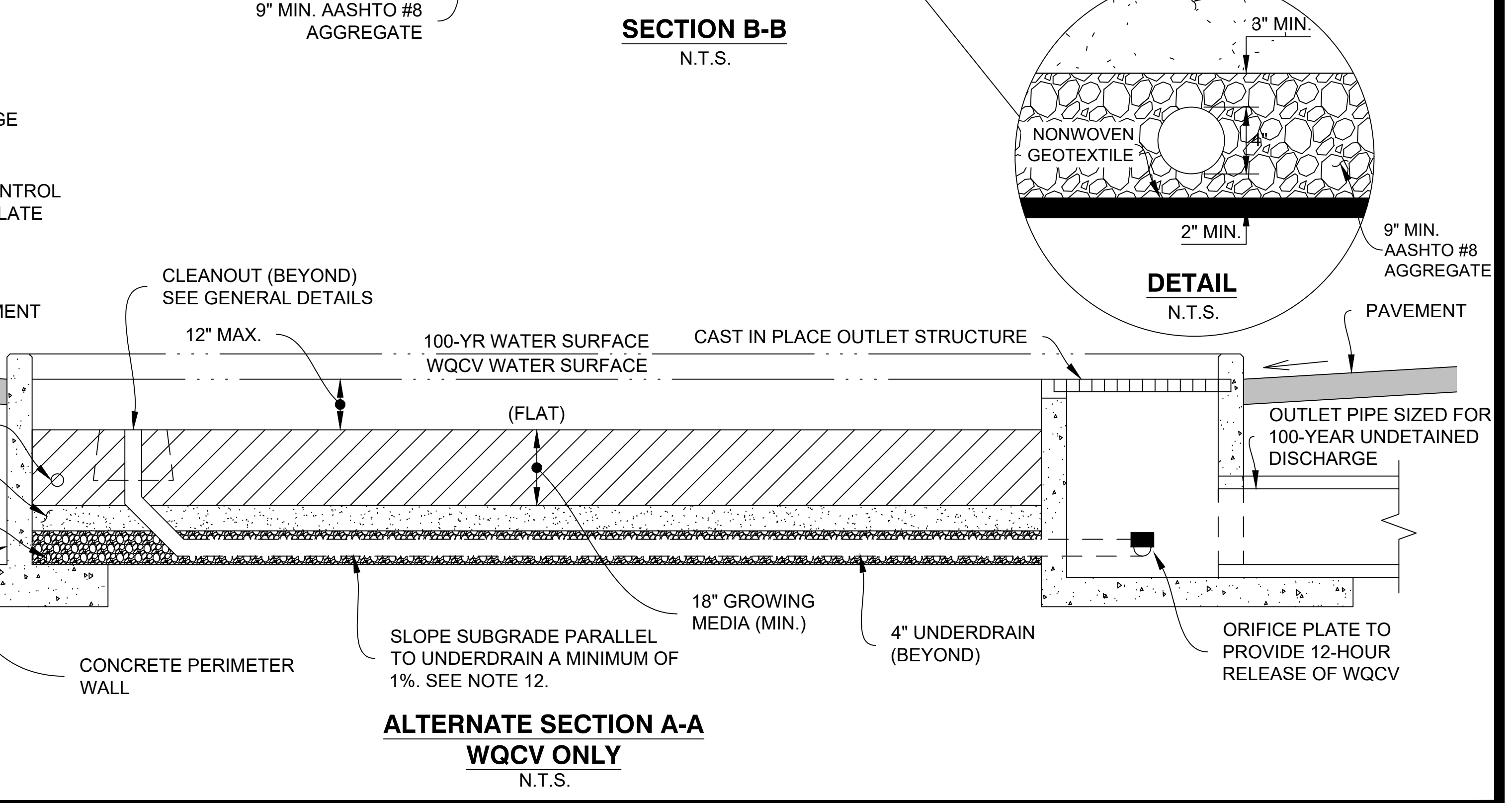
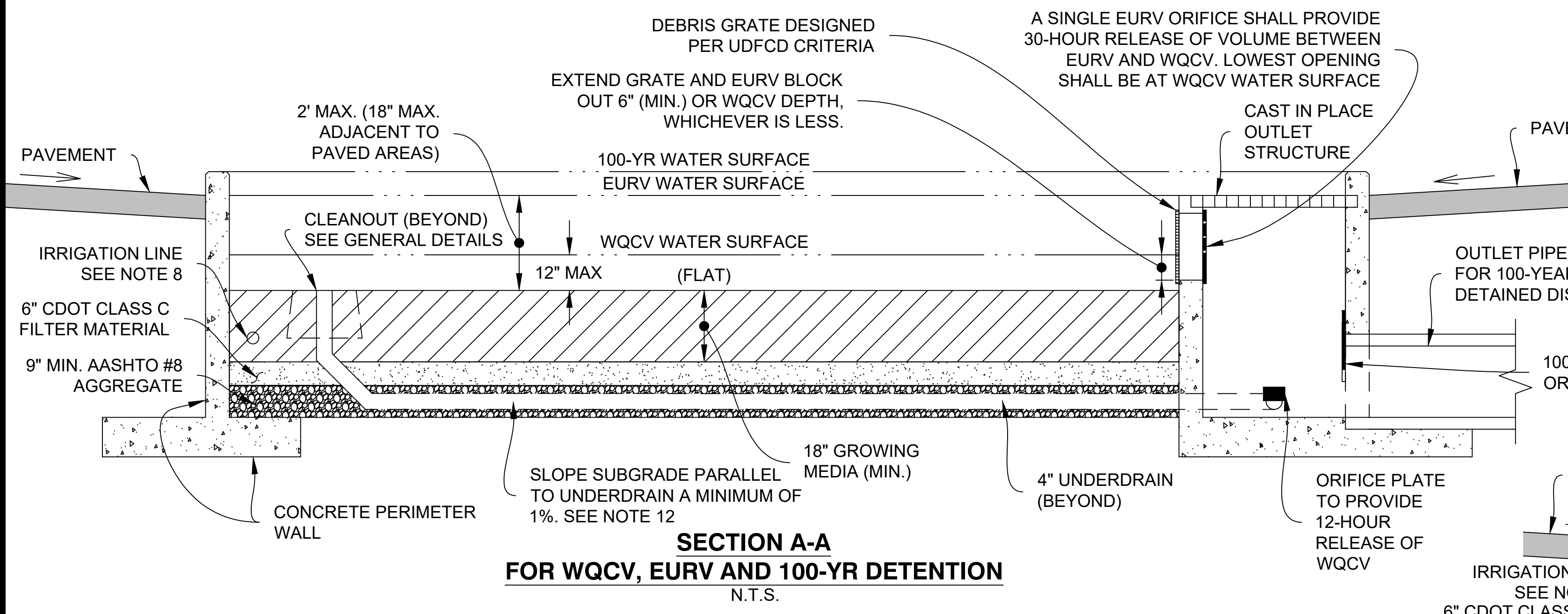
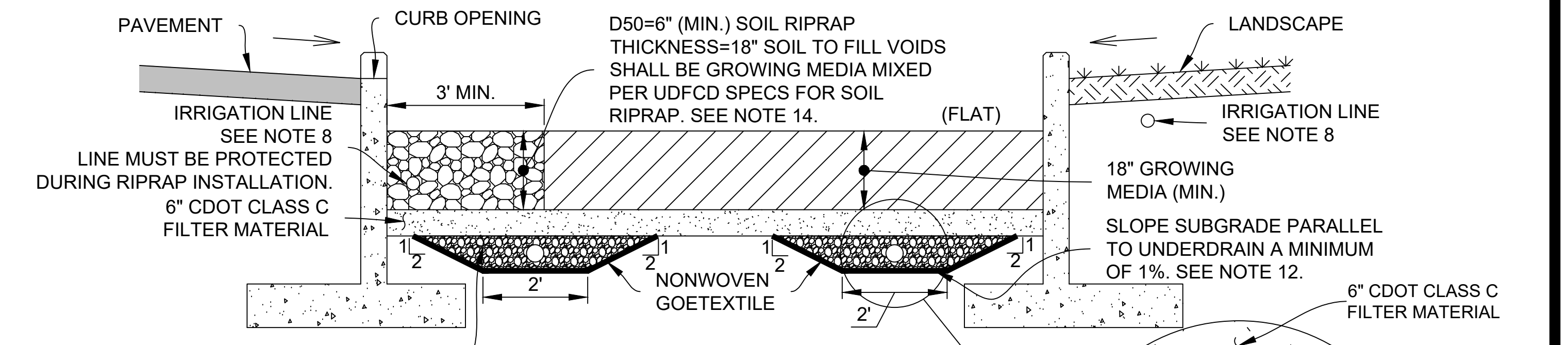

PLOTTED: 8/10/2020 4:25:02 PM

REFERENCE:	SCALE:	Standard Plan Revision	
		No.	Date



6924 S. LIMA ST.
CENTENNIAL, CO 80112
PHONE (720) 874-6500
www.arapahoegov.com

**BIORETENTION (RAIN GARDEN)
CONSTRAINED (WITH WALLS)
PARTIAL INFILTRATION**